

CS-2315
22⁷/₈" x 15" x 5" 2 molds

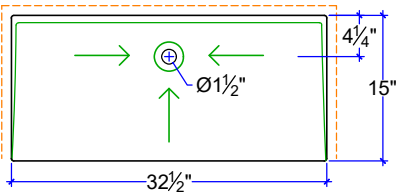

CS-3315
32¹/₂" x 15" x 5" 2 molds

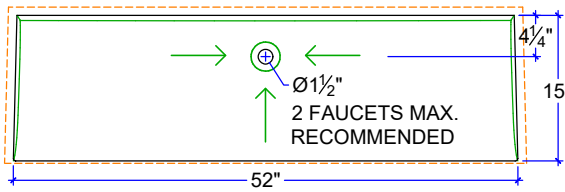

CS-5215
52" x 15" x 5" 2 molds

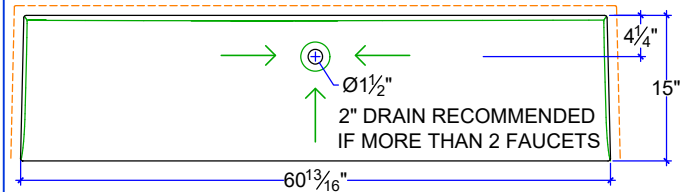

CS-6015
60¹³/₁₆" x 15" x 5" 2 molds

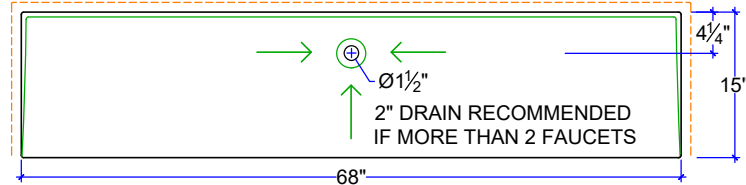

CS-6815
68" x 15" x 5" 1 mold

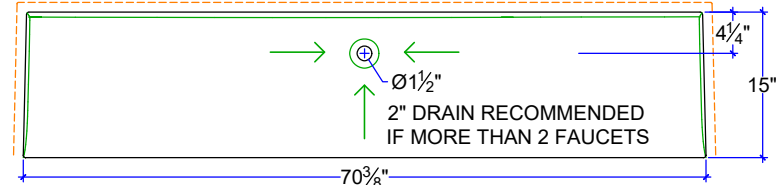

CS-7015
70³/₈" x 15" x 5" 2 molds

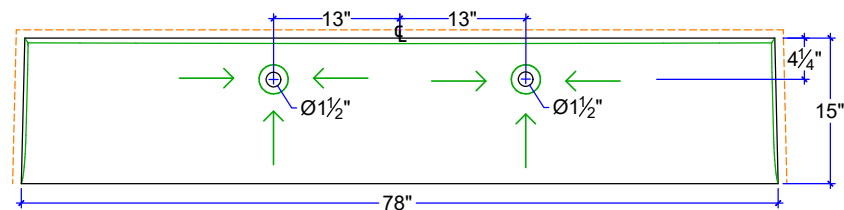

CS-7815
78" x 15" x 5" 2 molds

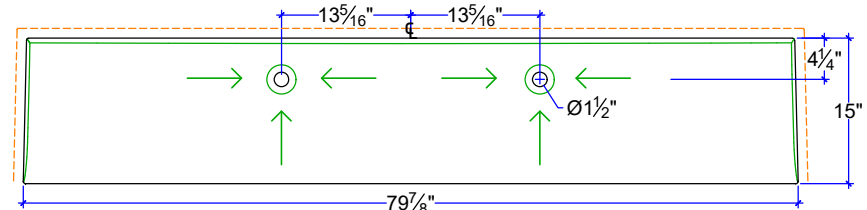

CS-8015 (2 MOLDS)
79⁷/₈" x 15" x 5" 2 molds

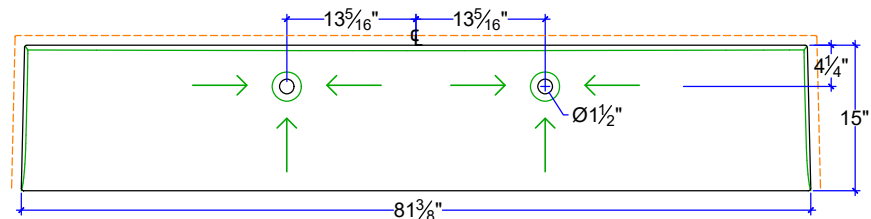

CS-8115 (2 MOLDS)
81³/₈" x 15" x 5" 2 molds

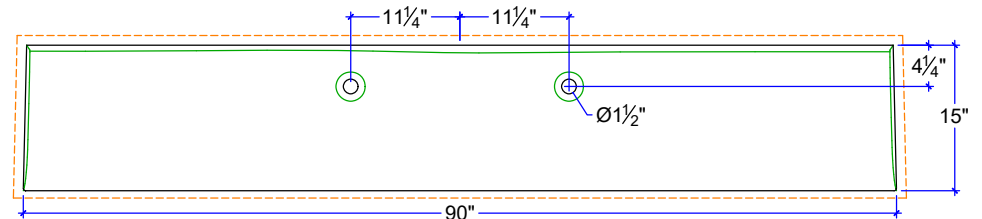

CS-9015
90" x 15" x 5" 2 molds



TYP. FRONT SECTION,
SINGLE DRAIN MODELS



TYP. FRONT SECTION, TWO DRAIN MODELS



TYP TRANSVERSE SECTIONS

RECTANGULAR
"SCOOP"

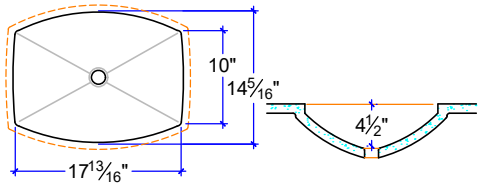

CS-1714* ^
17 13/16" x 14 5/16" x 4 1/2"
2 molds

CS-1714
SECTION -SIDE SEC.

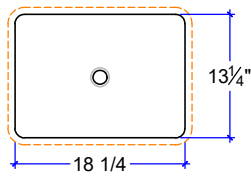

CS-1813
18 1/4" x 13 1/4" x 6 3/8"

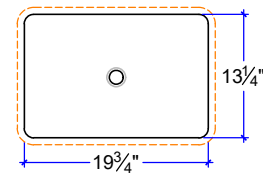

CS-1913*
19 3/4" x 13 1/4" x 7"
2 molds

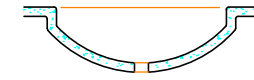

"SCOOP" SINK
SECTION -FRONT SEC.
CS-1813 & CS-1913*

RECTANGULAR
"CRESCENT"

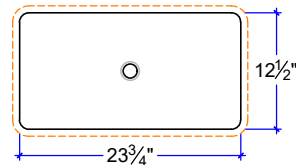

CS-2312
23 3/4" x 12 1/2" x 7 1/2"

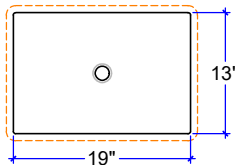

CS-1913-C*
19" x 13" x 7 1/2"
3 molds

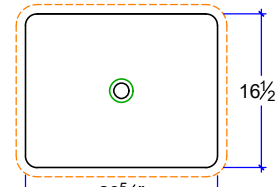

CS-2117-C
20 5/8" x 16 1/2" x 7 1/2"

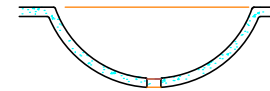

"CRESCENT" SINK
SECTION -FRONT SEC.



"CRESCENT" SINK
+ CS-1813, CS-1913, CS-2117
SIDE SEC.

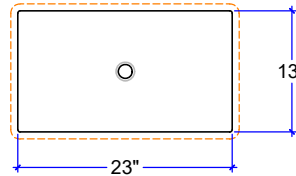

CS-2313*
23" x 13" x 7 1/2"
2 molds

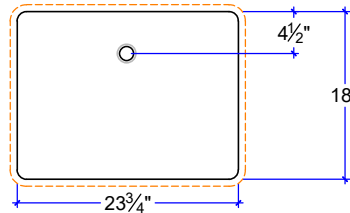

CS-2418
23 3/4" x 18" x 7 1/2"

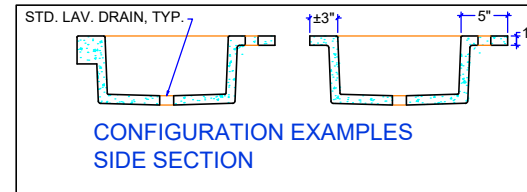

CONFIGURATION EXAMPLES
SIDE SECTION

RECTANGULAR
"WEDGE"

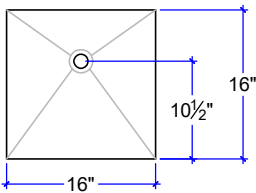

CS-1616 "Executive" * ^
16" x 16" x 2 1/2"
6 molds



FRONT

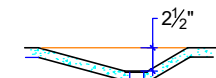

SIDE

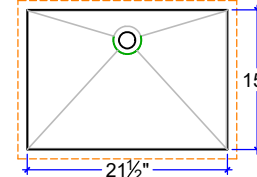

CS-2215 ^
21 1/2" x 15" x 3 1/4"



FRONT



SIDE

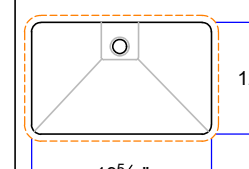

CS-1912
19 5/16" x 12" x 7 1/2"

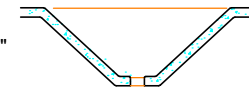

FRONT SECTION

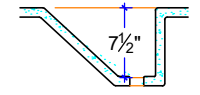

SIDE SECTION

SIDE SLOPE
CURVED

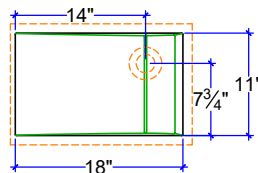

CS-1811 *
18" x 11" x 5"
2 molds

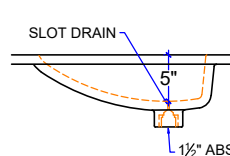

FRONT

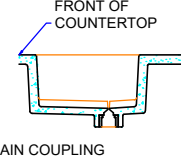

SIDE SECTION

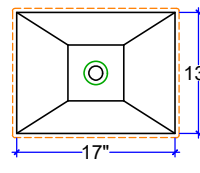

CS-1713
17" x 13" x 6 1/8"

CUSTOM SIZE COUNTERTOP WITH FIXED SIZE BASIN
DIMENSIONS ARE INSIDE SINK

* THESE MODELS ARE AVAILABLE AS MULTIPLE-SINK VANITIES

^ THESE MODELS CAN COMPLY WITH A.D.A. STANDARDS



© SONOMA CAST STONE
CONCRETE INNOVATIONS

(877) 283-2400 sales@sonomastone.com
www.sonomastone.com All rights reserved.

Custom CounterSinks
Rectangular



<p>CS-1008-FB 9 1/2" x 7 1/2" x 3 1/2" *^ 2 molds</p>	<p>CS-1212-FB ^ 12 1/2" x 12 1/2" x 5 3/4"</p>	<p>CS-1408-FB ^ 14" x 8" x 5"</p>	<p>CS-1414-FB 13 5/8" x 13 5/8" x 6 1/4"</p>	<p>CS-1708-SFB 17 x 8 x 4 1/8" ^</p>	<p>CS-1813-FB 17 1/2" x 13" x 6 1/8"</p>	<p>CS-1814-FBR*^ 18" x 14" x 4 1/2" 5 molds</p>	<p>CS-1914-FBR ^ 19 1/4" x 13 1/2" x 3 7/8"</p>
--	---	--	---	---	---	--	--

<p>CS-1915-FB 18 1/2" x 15" x 6 1/8"</p>	<p>CS-2010-FB^ 20" x 10" x 5"</p>	<p>CS-2012-SW^ 20 1/4" x 12 1/2" x 4 1/4" (offset drain hardware req. for ADA- by others)</p>	<p>CS-2013-FB* 20" x 13" x 6 1/4" 2 molds</p>	<p>CS-2013-FBR* 20" x 13" x 6" 2 molds</p>	<p>CS-2014-SFB 20" x 14" x 5" 3 molds</p>	<p>CS-2113-FB 20 1/2" x 13" x 6 1/8"</p>	<p>CS-2115-FB* 21" x 15" x 6 1/8" 2 molds</p>
---	--	--	--	---	--	---	--

<p>CS-2412-FB*^ 24" x 12" x 4" 3 molds</p>	<p>CS-2414-FB*^ 24" x 14" x 4 1/8" (offset drain hardware req. for ADA- by others) 4 molds</p>	<p>CS-2415-SFB 24" x 15" x 5 1/8" 2 molds</p>	<p>CS-2914-FBR ^ 29 1/8" x 14" x 4 1/8"</p>	<p>CS-3016-FB 30" x 16" x 5 1/2"</p>
---	---	--	--	---

CUSTOM SIZE COUNTERTOP WITH FIXED SIZE BASIN
DIMENSIONS ARE INSIDE SINK

* THESE MODELS ARE AVAILABLE AS MULTIPLE-SINK VANITIES

^ THESE MODELS CAN COMPLY WITH A.D.A. STANDARDS

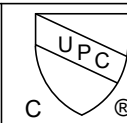

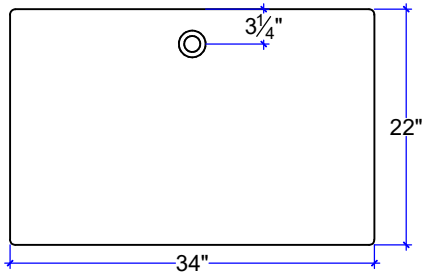

CS-3422-FBR
34" x 22" x 2 1/2"

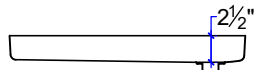

SIDE SECTION

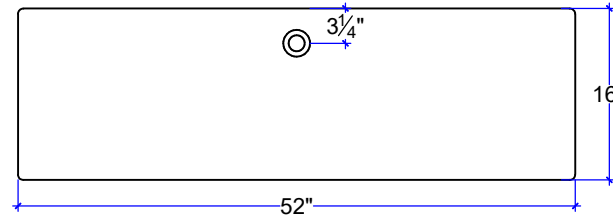

CS-5216-FBR
52" x 16" x 2 1/2"

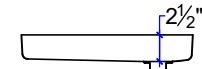

SIDE SECTION

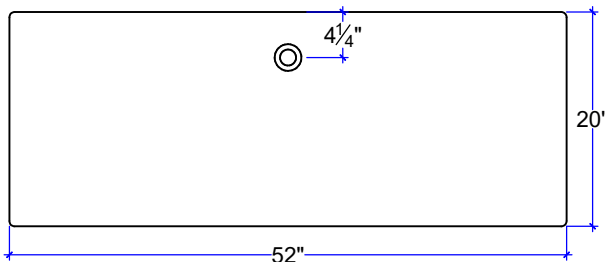

CS-5220-FBR
52" x 20" x 2 1/2"

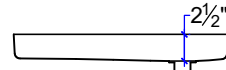

SIDE SECTION

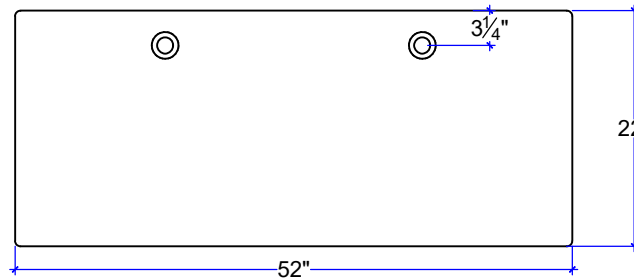

CS-5222-FBR
52" x 22" x 3"

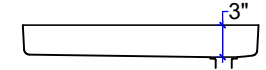

SIDE SECTION

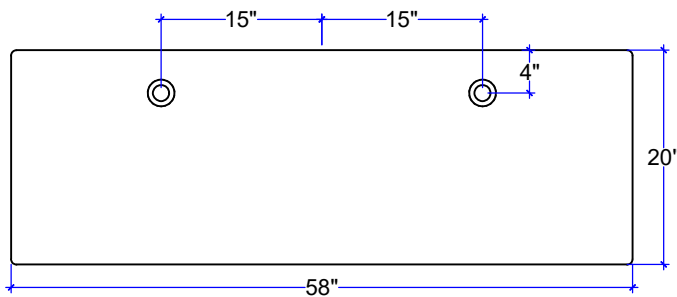

CS-5820-FBR
58" x 20" x 3"

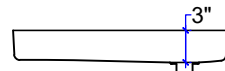

SIDE SECTION

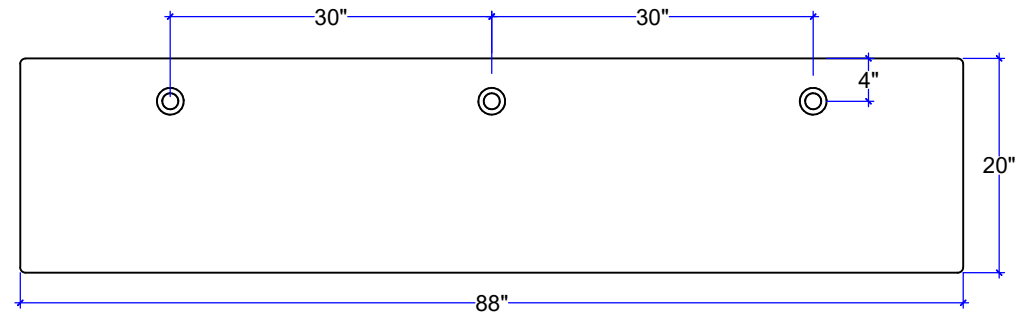

CS-8820-FBR
88" x 20" x 3"

CUSTOM SIZE COUNTERTOP WITH FIXED SIZE BASIN
DIMENSIONS ARE INSIDE SINK
THESE MODELS CAN COMPLY WITH A.D.A. STANDARDS



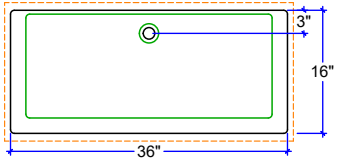

CS-3616-FBR
36" x 16" x 6 1/2"

SIDE SECTION

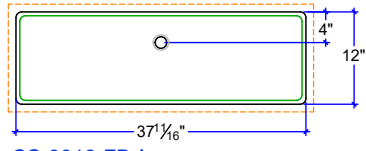

CS-3812-FB ^
37 1/16" x 12" x 5"

SIDE SECTION

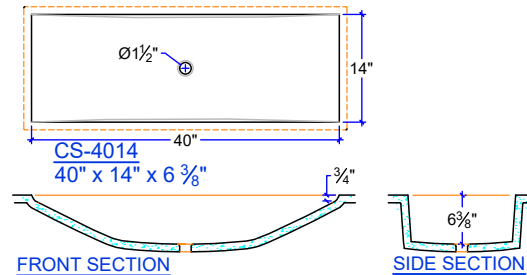

CS-4014
40" x 14" x 6 3/8"

FRONT SECTION

SIDE SECTION

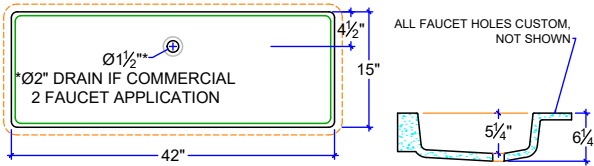

CS-4215-FB ^A.D.A. COMPLIANT
42" x 15" x 5 1/4"

TYP. SIDE SECTION

ALL FAUCET HOLES CUSTOM, NOT SHOWN

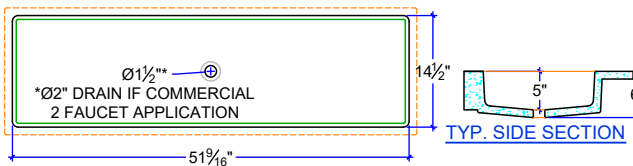

CS-5215-FB ^A.D.A. COMPLIANT
51 1/16" x 14.5" x 5"

(offset drain hardware req. for ADA- by others)

TYP. SIDE SECTION

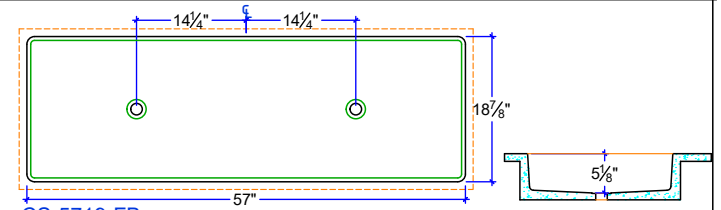

CS-5719-FB
57" x 18 7/8" x 5 1/8"

SIDE SECTION

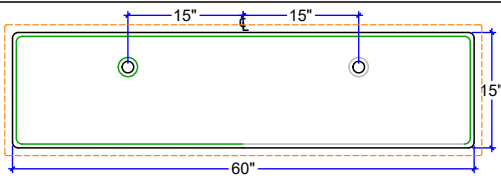

CS-6015-FB ^A.D.A. COMPLIANT
60" x 15" x 4" 2 MOLDS

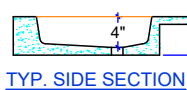

TYP. SIDE SECTION

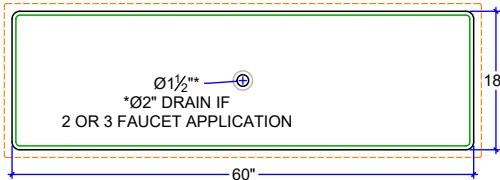

CS-6018-FB
60" x 18" x 6"

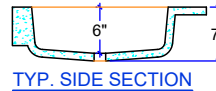

TYP. SIDE SECTION

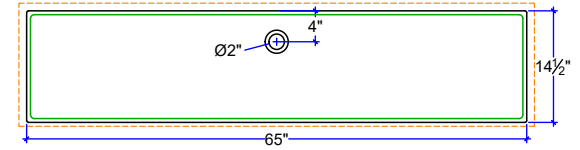

CS-6515-FB ^A.D.A. COMPLIANT
65" x 14.5" x 4"

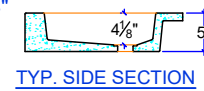

TYP. SIDE SECTION

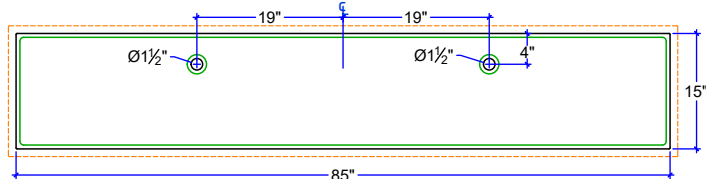

CS-8515-FB ^A.D.A. COMPLIANT
85" x 15" x 4"

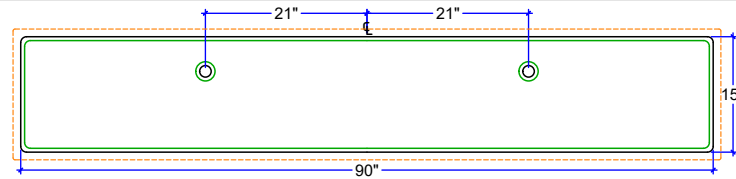

CS-9015-FB ^A.D.A. COMPLIANT
90" x 15" x 4"

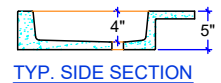

TYP. SIDE SECTION

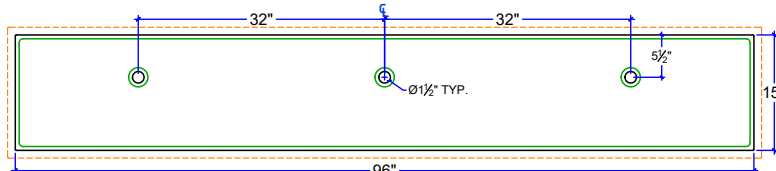

CS-9615-FB ^A.D.A. COMPLIANT
96" x 15" x 4"

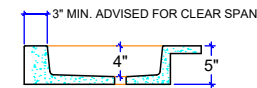

SIDE SECTION

CUSTOM SIZE COUNTERTOP WITH FIXED SIZE BASIN
DIMENSIONS ARE INSIDE SINK

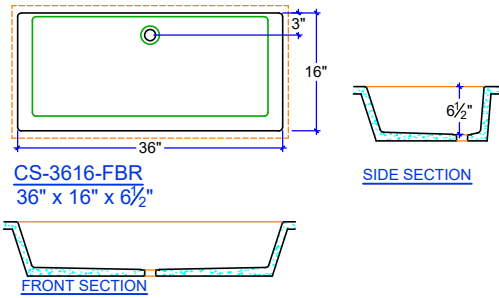

CS-3616-FBR
36" x 16" x 6 1/2"

SIDE SECTION

FRONT SECTION

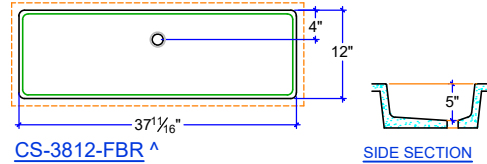

CS-3812-FBR ^
37 1/16" x 12" x 5"

SIDE SECTION

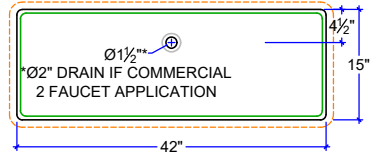

CS-4215-FBR ^
42" x 15" x 5 1/4"



ALL FAUCET HOLES CUSTOM,
NOT SHOWN.

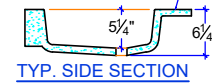

TYP. SIDE SECTION

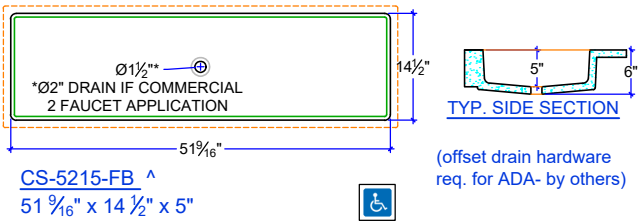

CS-5215-FB ^
51 1/16" x 14 1/2" x 5"

(offset drain hardware
req. for ADA- by others)

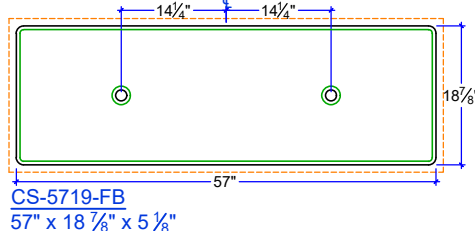

CS-5719-FB
57" x 18 7/8" x 5 1/8"

SIDE SECTION

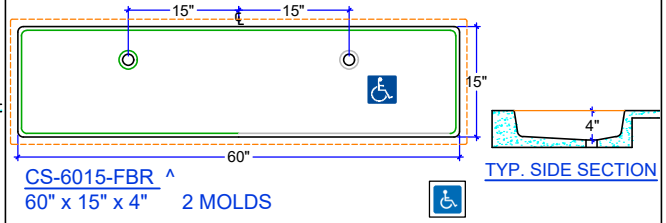

CS-6015-FBR ^
60" x 15" x 4" 2 MOLDS

TYP. SIDE SECTION

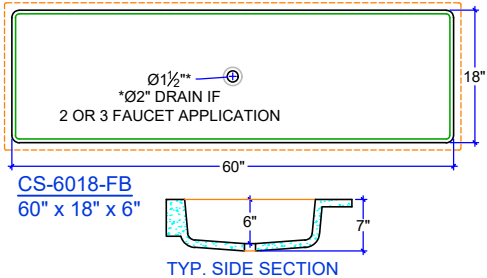

CS-6018-FB
60" x 18" x 6"

TYP. SIDE SECTION

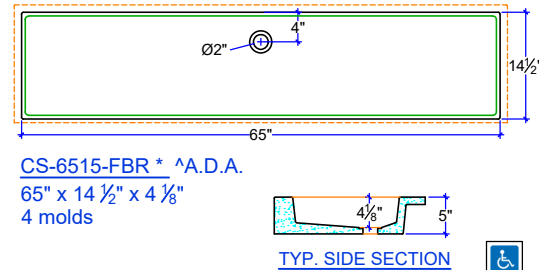

CS-6515-FBR * ^A.D.A.
65" x 14 1/2" x 4 1/8"
4 molds

TYP. SIDE SECTION

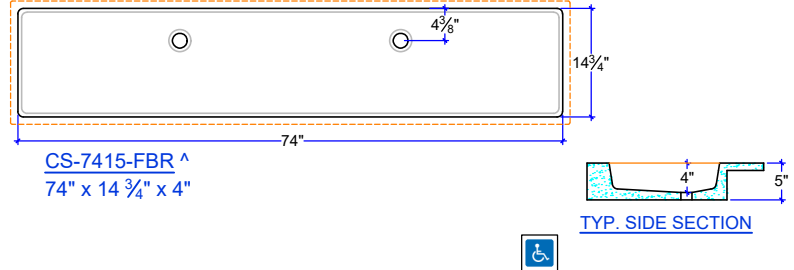

CS-7415-FBR ^
74" x 14 3/4" x 4"

TYP. SIDE SECTION

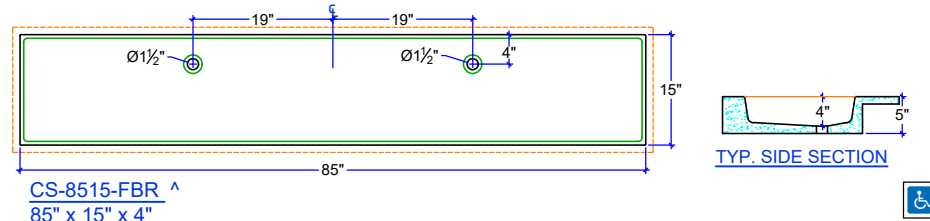

CS-8515-FBR ^
85" x 15" x 4"

TYP. SIDE SECTION

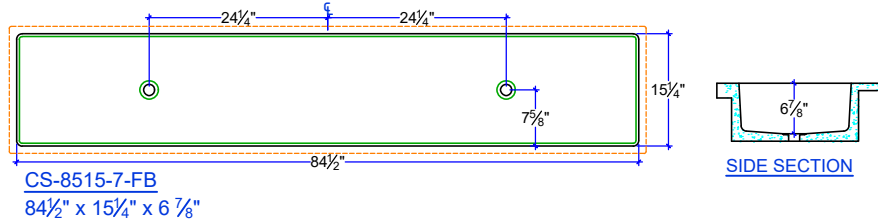

CS-8515-7-FB
84 1/2" x 15 1/4" x 6 7/8"

SIDE SECTION

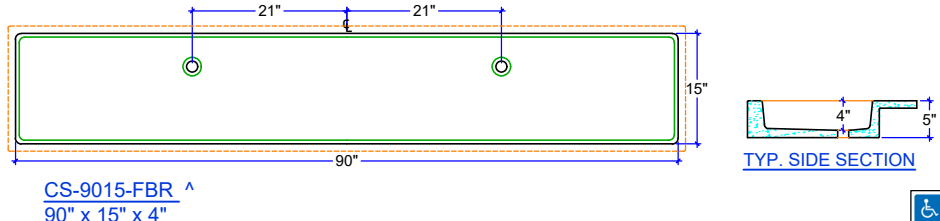

CS-9015-FBR ^
90" x 15" x 4"

TYP. SIDE SECTION

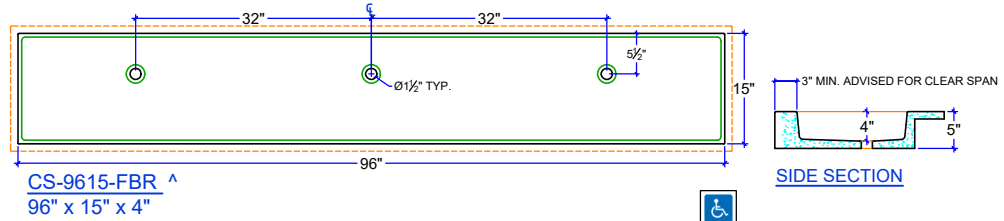

CS-9615-FBR ^
96" x 15" x 4"

SIDE SECTION



CUSTOM SIZE COUNTERTOP WITH FIXED SIZE BASIN
DIMENSIONS ARE INSIDE SINK

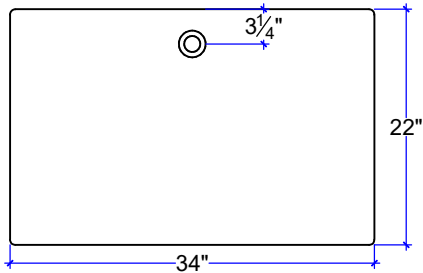

CS-3422-FBR
34" x 22" x 2½"

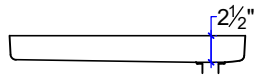

SIDE SECTION

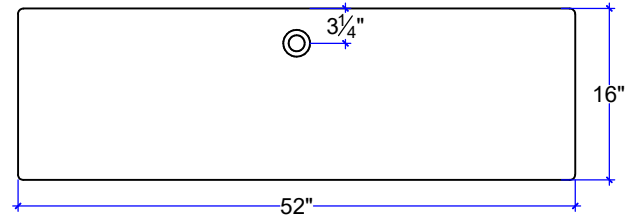

CS-5216-FBR
52" x 16" x 2½"

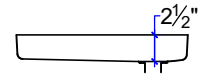

SIDE SECTION

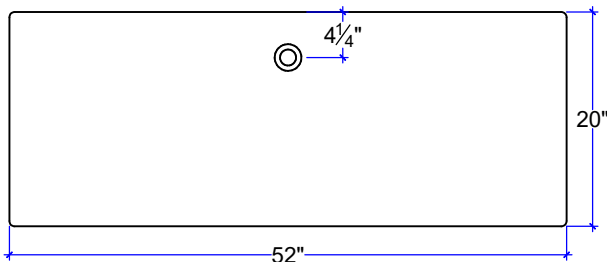

CS-5220-FBR
52" x 20" x 2½"

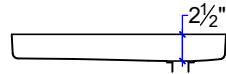

SIDE SECTION

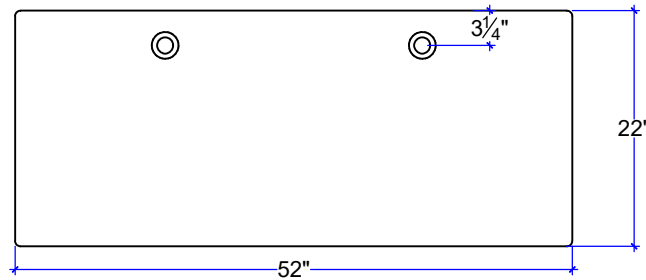

CS-5222-FBR
52" x 22" x 3"

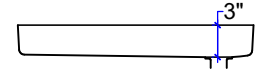

SIDE SECTION

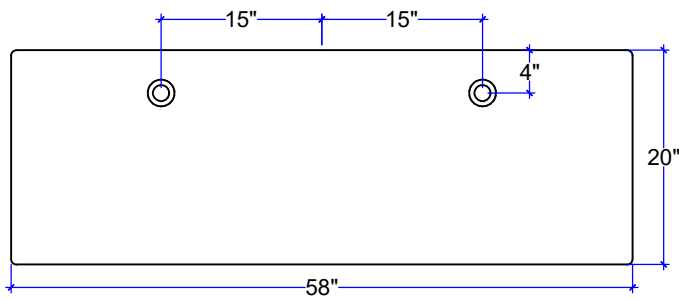

CS-5820-FBR
58" x 20" x 3"

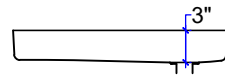

SIDE SECTION

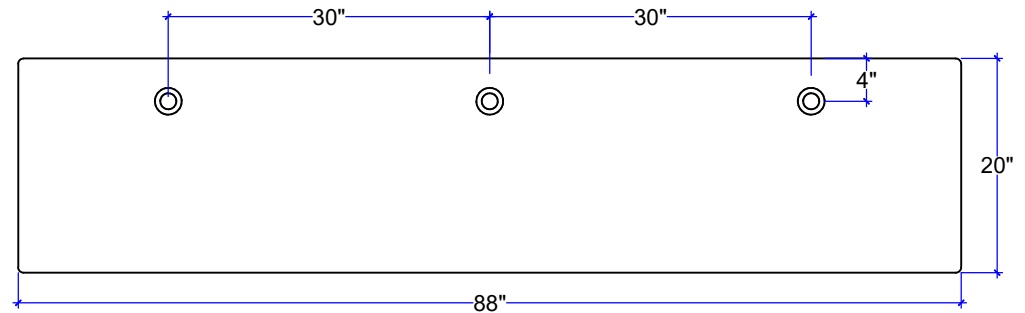

CS-8820-FBR
88" x 20" x 3"

CUSTOM SIZE COUNTERTOP WITH FIXED SIZE BASIN
DIMENSIONS ARE INSIDE SINK
THESE MODELS CAN COMPLY WITH A.D.A. STANDARDS



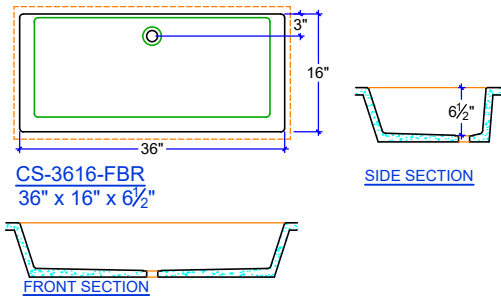

CS-3616-FBR
36" x 16" x 6 1/2"

SIDE SECTION

FRONT SECTION

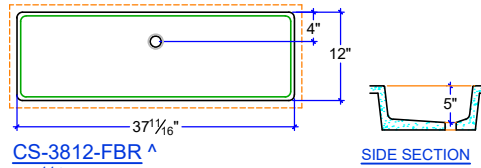

CS-3812-FBR ^
37 1/16" x 12" x 5"

SIDE SECTION

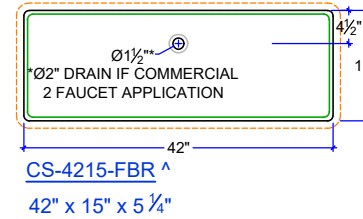

CS-4215-FBR ^
42" x 15" x 5 1/4"

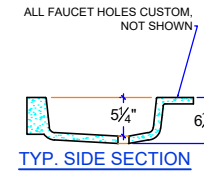

TYP. SIDE SECTION

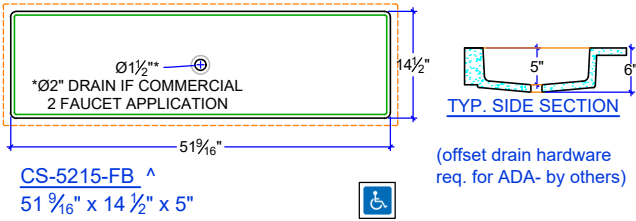

CS-5215-FB ^
51 1/16" x 14 1/2" x 5"

TYP. SIDE SECTION

(offset drain hardware req. for ADA- by others)

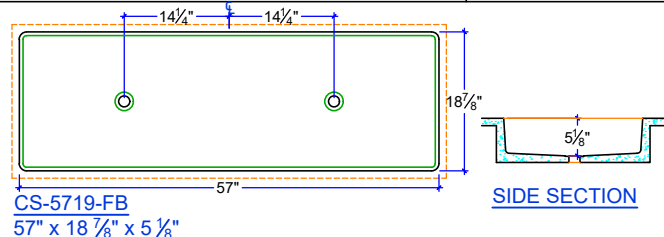

CS-5719-FB
57" x 18 7/8" x 5 1/8"

SIDE SECTION

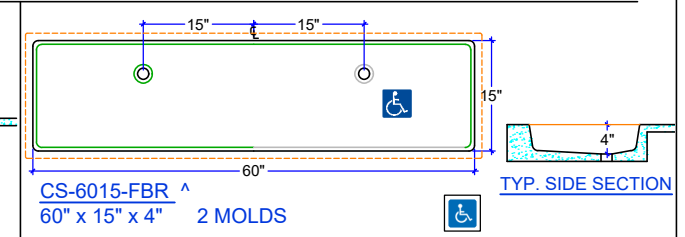

CS-6015-FBR ^
60" x 15" x 4" 2 MOLDS

TYP. SIDE SECTION

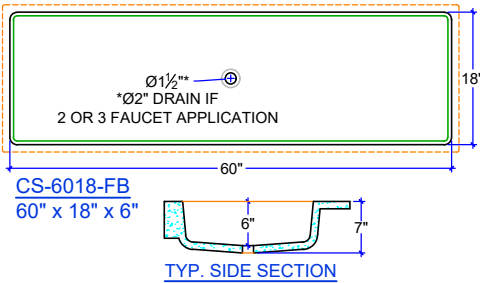

CS-6018-FB
60" x 18" x 6"

TYP. SIDE SECTION

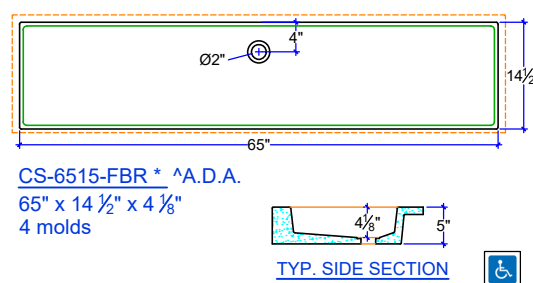

CS-6515-FBR * ^A.D.A.
65" x 14 1/2" x 4 1/8"
4 molds

TYP. SIDE SECTION

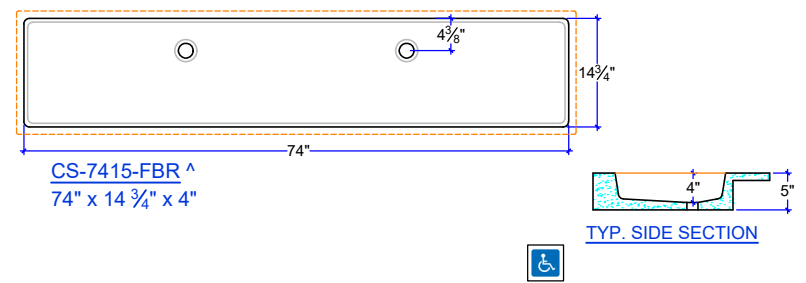

CS-7415-FBR ^
74" x 14 3/4" x 4"

TYP. SIDE SECTION

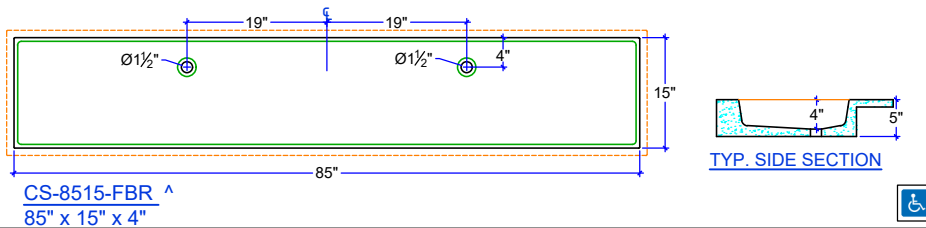

CS-8515-FBR ^
85" x 15" x 4"

TYP. SIDE SECTION

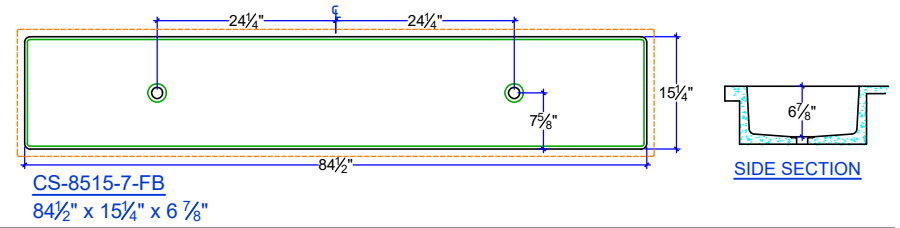

CS-8515-7-FB
84 1/2" x 15 1/4" x 6 7/8"

SIDE SECTION

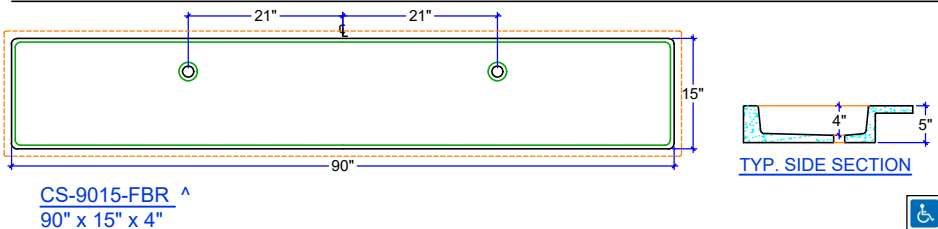

CS-9015-FBR ^
90" x 15" x 4"

TYP. SIDE SECTION

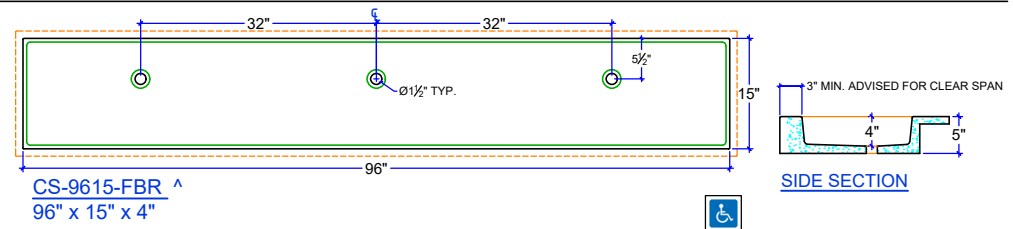

CS-9615-FBR ^
96" x 15" x 4"

SIDE SECTION



CUSTOM SIZE COUNTERTOP WITH FIXED SIZE BASIN
DIMENSIONS ARE INSIDE SINK

<p>CS-1008-FB 9 1/2" x 7 1/2" x 3 1/2" *^ 2 molds</p>	<p>CS-1212-FB ^ 12 1/2" x 12 1/2" x 5 3/4"</p>	<p>CS-1408-FB ^ 14" x 8" x 5"</p>	<p>CS-1414-FB 13 5/8" x 13 5/8" x 6 1/4"</p>	<p>CS-1708-SFB 17 x 8 x 4 1/8" ^</p>	<p>CS-1813-FB 17 1/2" x 13" x 6 1/8"</p>	<p>CS-1814-FBR*^ 18" x 14" x 4 1/2" 5 molds</p>	<p>CS-1914-FBR ^ 19 1/4" x 13 1/2" x 3 7/8"</p>
--	---	--	---	---	---	--	--

<p>CS-1915-FB 18 1/2" x 15" x 6 1/8"</p>	<p>CS-2010-FB^ 20" x 10" x 5"</p>	<p>CS-2012-SW^ 20 1/4" x 12 1/2" x 4 1/4" (offset drain hardware req. for ADA- by others)</p>	<p>CS-2013-FB* 20" x 13" x 6 1/4" 2 molds</p>	<p>CS-2013-FBR* 20" x 13" x 6" 2 molds</p>	<p>CS-2014-SFB 20" x 14" x 5" 3 molds</p>	<p>CS-2113-FB 20 1/2" x 13" x 6 1/8"</p>	<p>CS-2115-FB* 21" x 15" x 6 1/8" 2 molds</p>
---	--	--	--	---	--	---	--

<p>CS-2412-FB*^ 24" x 12" x 4" 3 molds</p>	<p>CS-2414-FB*^ 24" x 14" x 4 1/8" (offset drain hardware req. for ADA- by others) 4 molds</p>	<p>CS-2415-SFB 24" x 15" x 5 1/8" 2 molds</p>	<p>CS-2914-FBR ^ 29 5/8" x 14" x 4 1/8"</p>	<p>CS-3016-FB 30" x 16" x 5 1/2"</p>
---	---	--	--	---

CUSTOM SIZE COUNTERTOP WITH FIXED SIZE BASIN
DIMENSIONS ARE INSIDE SINK

* THESE MODELS ARE AVAILABLE AS MULTIPLE-SINK VANITIES

^ THESE MODELS CAN COMPLY WITH A.D.A. STANDARDS

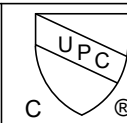

RECTANGULAR
"SCOOP"

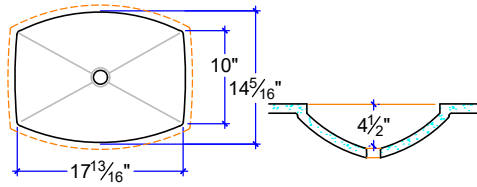

CS-1714* ^
17 13/16" x 14 5/16" x 4 1/2"
2 molds

CS-1714
SECTION -SIDE SEC.

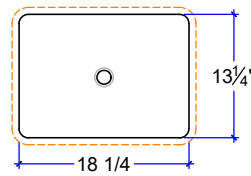

CS-1813
18 1/4" x 13 1/4" x 6 3/8"

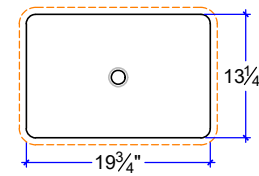

CS-1913*
19 3/4" x 13 1/4" x 7"
2 molds

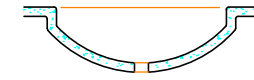

"SCOOP" SINK
SECTION -FRONT SEC.
CS-1813 & CS-1913*

RECTANGULAR
"CRESCENT"

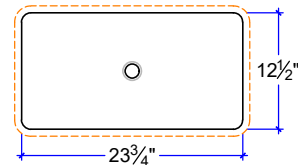

CS-2312
23 3/4" x 12 1/2" x 7 1/2"

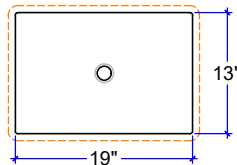

CS-1913-C*
19" x 13" x 7 1/2"
3 molds

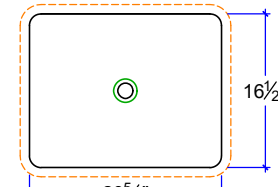

CS-2117-C
20 5/8" x 16 1/2" x 7 1/2"

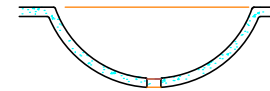

"CRESCENT" SINK
SECTION -FRONT SEC.



"CRESCENT" SINK
+ CS-1813, CS-1913, CS-2117
SIDE SEC.

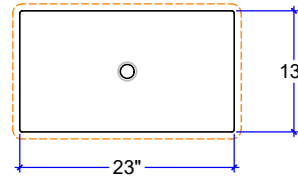

CS-2313*
23" x 13" x 7 1/2"
2 molds

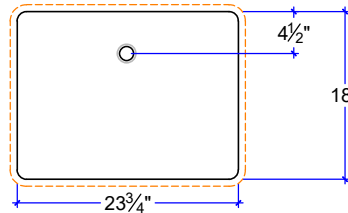

CS-2418
23 3/4" x 18" x 7 1/2"

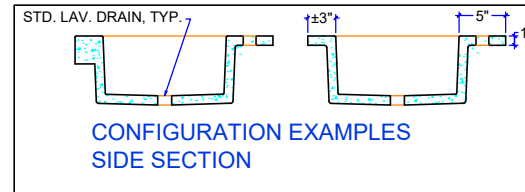

CONFIGURATION EXAMPLES
SIDE SECTION

RECTANGULAR
"WEDGE"

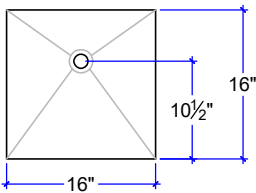

CS-1616 "Executive" * ^
16" x 16" x 2 1/2"
6 molds

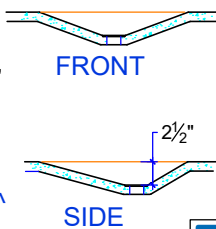

FRONT

SIDE

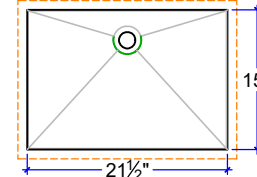

CS-2215 ^
21 1/2" x 15" x 3 1/4"

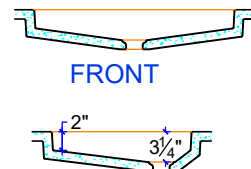

FRONT

SIDE

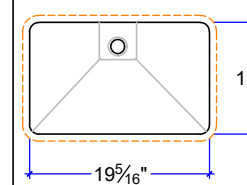

CS-1912
19 5/16" x 12" x 7 1/2"

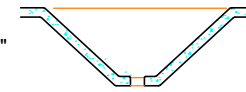

FRONT SECTION

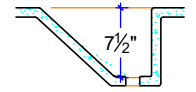

SIDE SECTION

SIDE SLOPE
CURVED

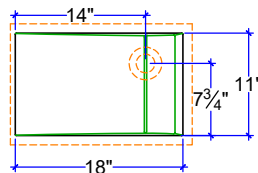

CS-1811 *
18" x 11" x 5"
2 molds

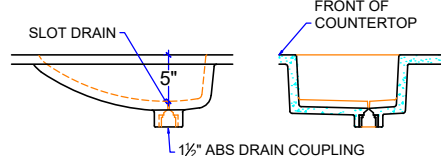

FRONT

SIDE SECTION

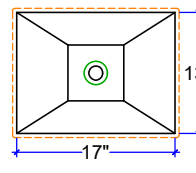

CS-1713
17" x 13" x 6 1/8"

CUSTOM SIZE COUNTERTOP WITH FIXED SIZE BASIN
DIMENSIONS ARE INSIDE SINK

* THESE MODELS ARE AVAILABLE AS MULTIPLE-SINK VANITIES

^ THESE MODELS CAN COMPLY WITH A.D.A. STANDARDS



© SONOMA CAST STONE
CONCRETE INNOVATIONS

(877) 283-2400 sales@sonomastone.com
www.sonomastone.com All rights reserved.

Custom CounterSinks
Rectangular





SONOMA CAST STONE
CONCRETE INNOVATIONS

LONG BASIN ADA COMPLIANT SINKS

-See Also- WaveSinks and other multiple-basin options-

BASIN LENGTHS:
INTEGRAL IN CUSTOM COUNTERTOP UP TO 108"

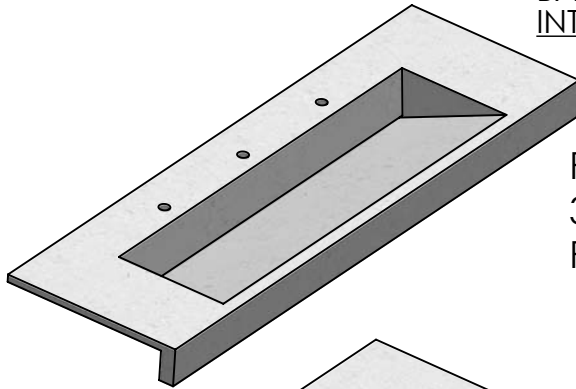

RampSinks, Slot Drain
32 lengths 10"-90" inside basin length
RMP-xxxx-B Model Numbers

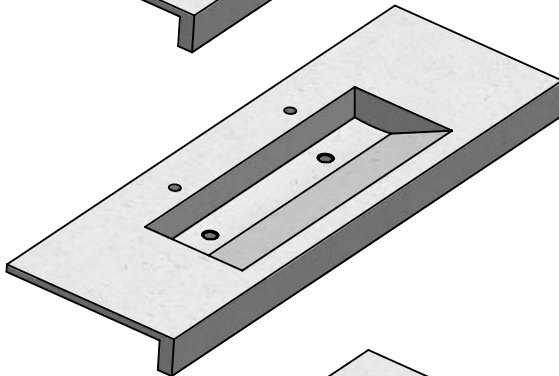

Flat-Bottom RampSinks, Standard Drain
lengths 16", 30", 40", 54" 84" inside basin length
RMP-xxxx-SD Model Numbers

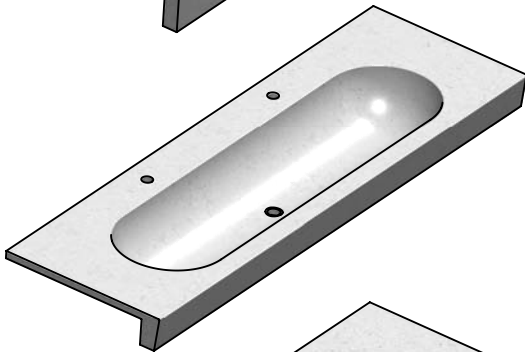

TroughSinks
lengths 27", 40", 48", 54", 66" inside basin length
TS-xxxx Model Numbers

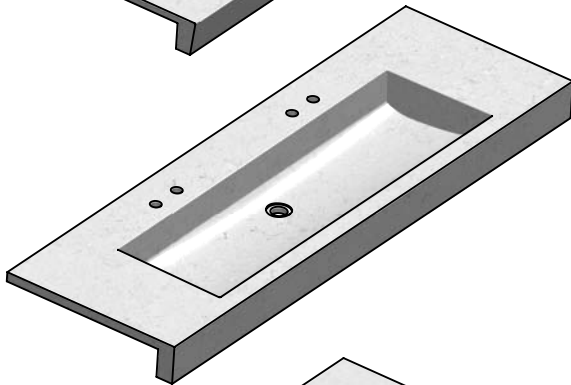

ChicagoSinks
lengths 52", 78", 90" inside basin length
CS-xxxx Model Numbers

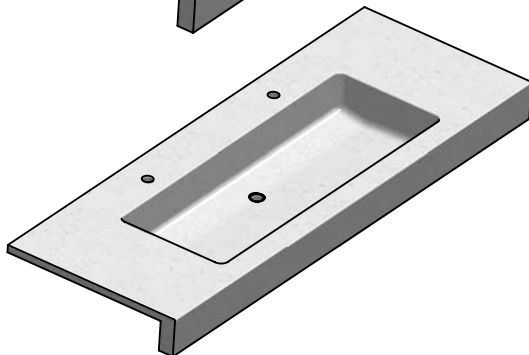

Flat-Bottom Countersinks
lengths 29", 42" inside basin length
CS-2914-FB & CS-4215-FB Models