

CS-3616-FBR
36" x 16" x 6 1/2"

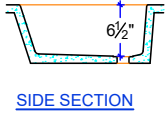

SIDE SECTION

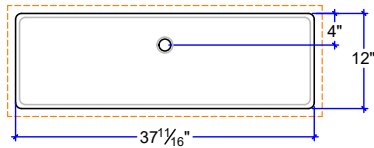

CS-3812-FB ^
37 1/16" x 12" x 5"

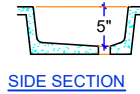

SIDE SECTION

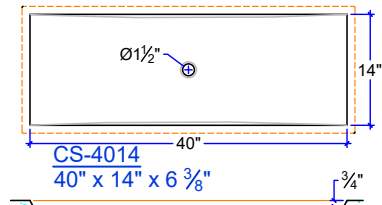

CS-4014
40" x 14" x 6 3/8"

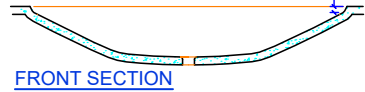

FRONT SECTION

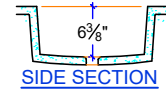

SIDE SECTION

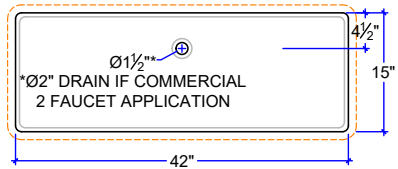

CS-4215-FB ^A.D.A. COMPLIANT
42" x 15" x 5 1/4"

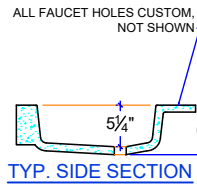

TYP. SIDE SECTION

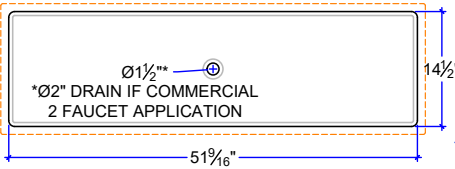

CS-5215-FB ^A.D.A. COMPLIANT (offset drain hardware req. for ADA- by others)
51.5" x 14.5" x 5"

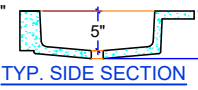

TYP. SIDE SECTION

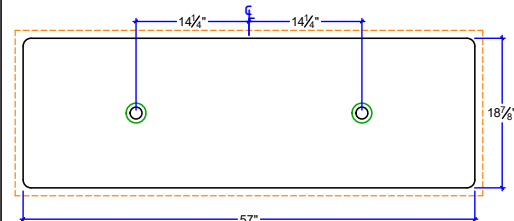

CS-5719-FB

SIDE SECTION

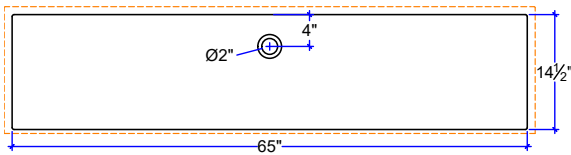

CS-6515-FB ^A.D.A. COMPLIANT
65" x 14.5" x 4"

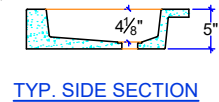

TYP. SIDE SECTION

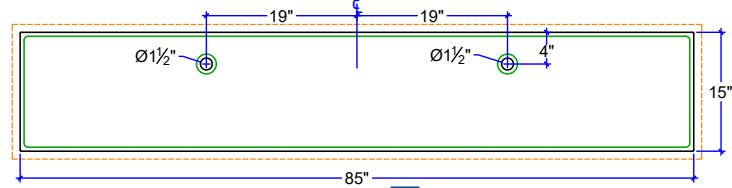

CS-8515-FB ^A.D.A. COMPLIANT
85" x 15" x 4"

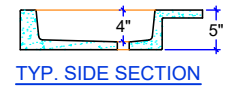

TYP. SIDE SECTION

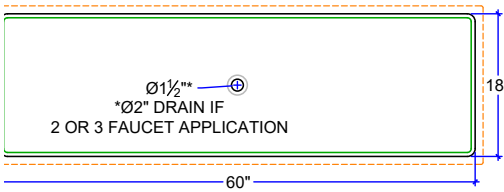

CS-6018-FB
60" x 18" x 6"

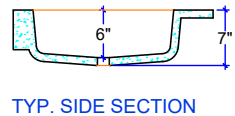

TYP. SIDE SECTION

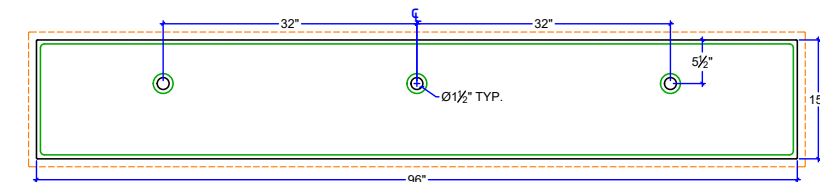

CS-9615-FB ^A.D.A. COMPLIANT
96" x 15" x 4"



9615 FRONT SECTION

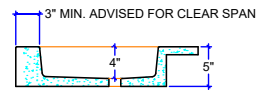

SIDE SECTION

CUSTOM SIZE COUNTERTOP WITH FIXED SIZE BASIN
DIMENSIONS ARE INSIDE SINK

ROUND

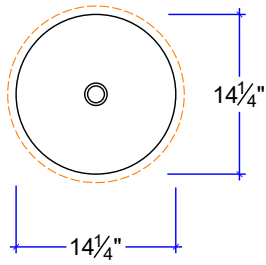

CS-14D*
14" DIA. x 4 7/8" DEEP

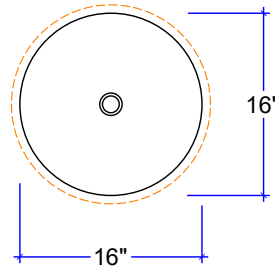

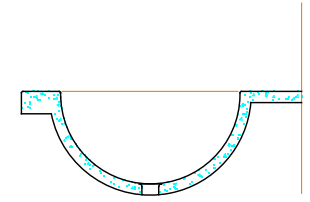

CS-16D*
16" DIA. x 8" DEEP



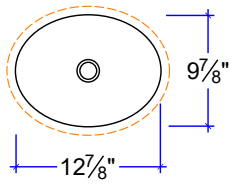

ROUND SINK SECTION

OVAL
W/CENTER DRAIN

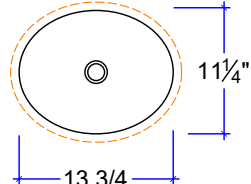

CS-1310^
12 7/8" x 9 7/8" x 4 1/2"



CS-1311^
13 3/4" x 11 1/8" x 4 5/8"

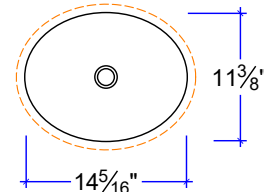

CS-1411*
14 5/16" x 11 3/8" x 5 7/8"

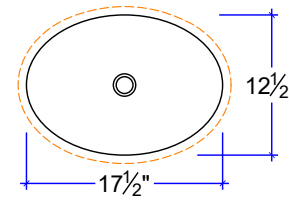

CS-1712*
17 1/2" x 12 1/2" x 5 3/4"

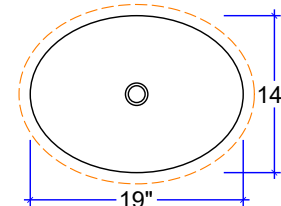

CS-1914
19" x 14" x 5 3/4"

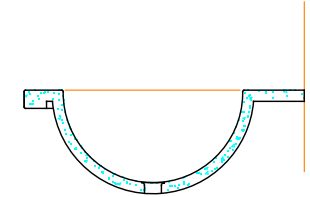

OVAL SINK SECTION
W/ CENTER DRAIN

OVAL
W/OFFSET DRAIN

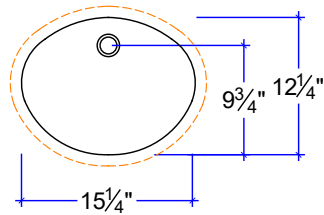

CS-1512
15 1/4" x 12 1/4" x 5 3/4"

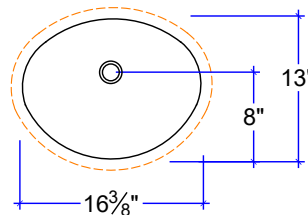

CS-1613
16 3/8" x 13" x 5 1/2"

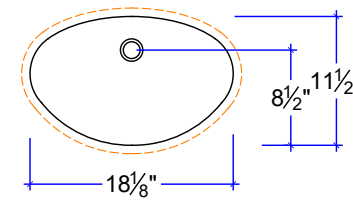

CS-1811
18 1/8" x 11 1/2" x 5 7/8"

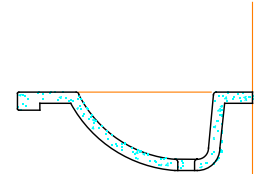

OVAL SINK SECTION
W/ OFFSET DRAIN

CUSTOM SIZE COUNTERTOP WITH FIXED SIZE BASIN. DIMENSIONS ARE INSIDE SINK.

* THESE MODELS ARE AVAILABLE AS MULTI-SINK VANITIES

^ THESE MODELS CAN COMPLY WITH A.D.A. STANDARDS

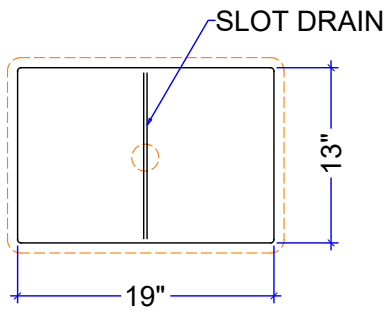

CS-1913-C-SD*
6 1/2" DEEP

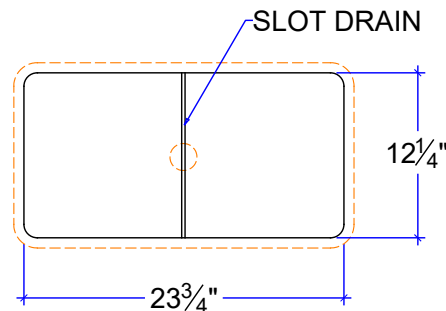

CS-2312-SD
7 1/2" DEEP

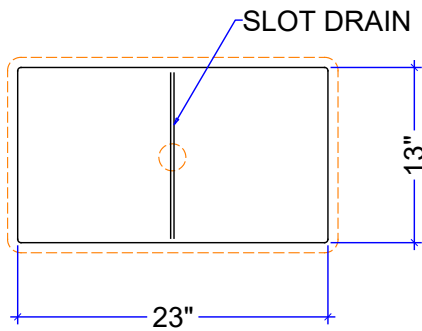

CS-2313-SD*
6 1/2" DEEP

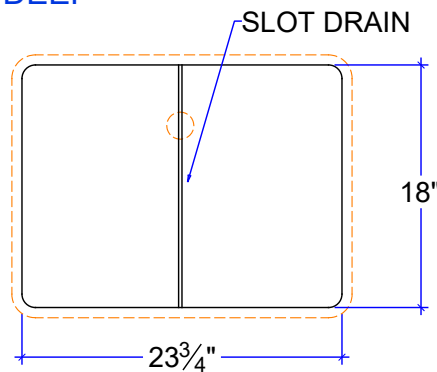

CS-2418-SD
7 1/2" DEEP

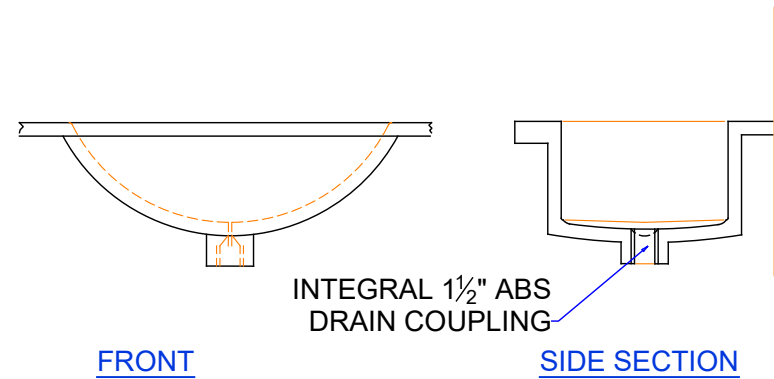

FRONT

SIDE SECTION

INTEGRAL 1/2" ABS
DRAIN COUPLING

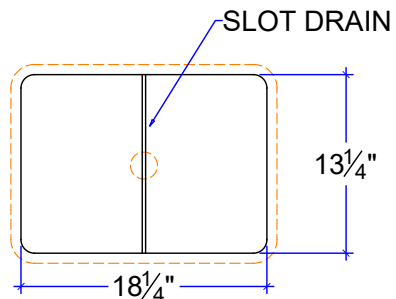

CS-1813-SD
6 3/8" DEEP

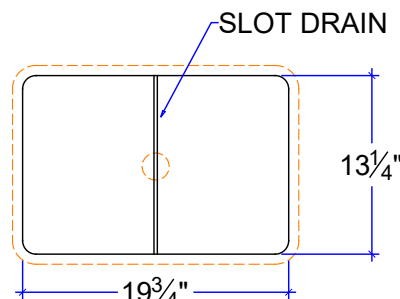

CS-1913-SD
7" DEEP

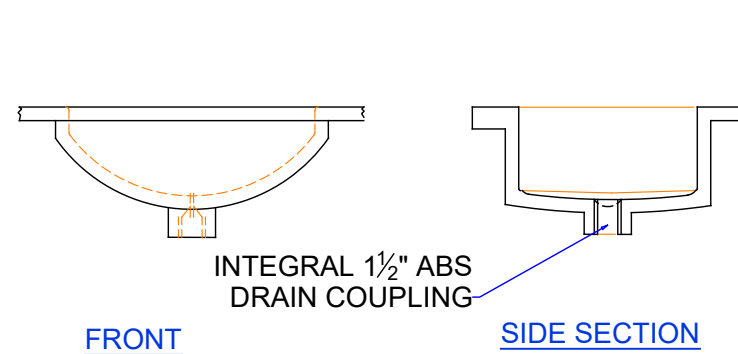

FRONT

SIDE SECTION

INTEGRAL 1/2" ABS
DRAIN COUPLING