



SONOMA CAST STONE / 877.283.2400

# CUSTOM BATH PRODUCTS

Visit [www.sonomastone.com](http://www.sonomastone.com) to see photos.  
Designs ©2009 Sonoma Cast Stone Corp. All rights reserved.

## MODEL: INTEGRAL COUNTERSINK - RECTANGLE EXAMPLE

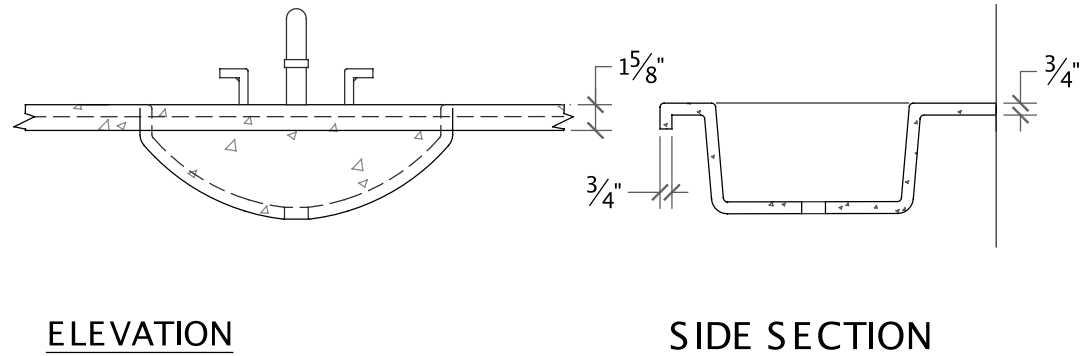
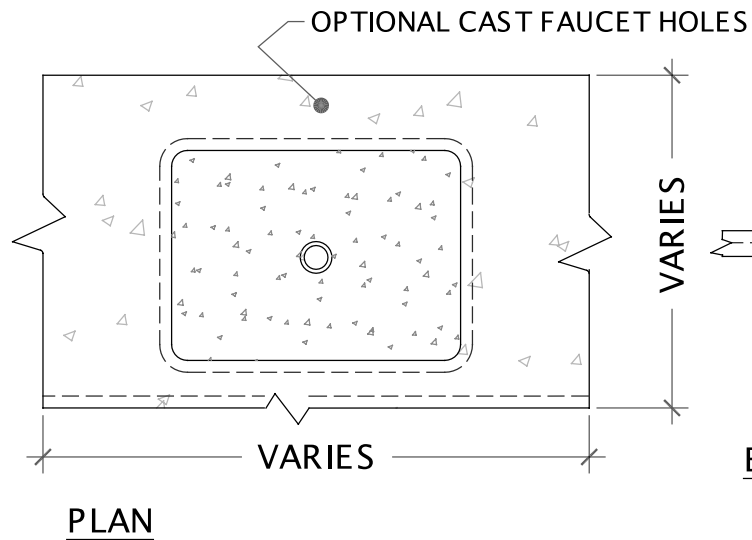

CONCRETE COUNTER W/INTEGRAL COUNTERSINK



SONOMA CAST STONE / 877.283.2400

# CUSTOM BATH PRODUCTS

Visit [www.sonomastone.com](http://www.sonomastone.com) to see photos.  
 Designs ©2009 Sonoma Cast Stone Corp. All rights reserved.

## MODEL: INTEGRAL COUNTERSINK - RECTANGLE SIZES

### RECTANGULAR "SCOOP"

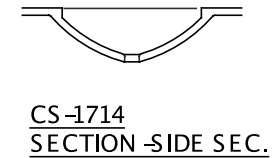
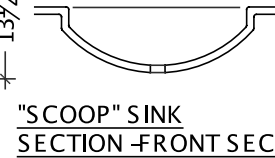
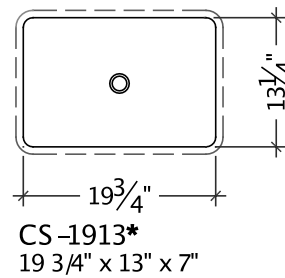
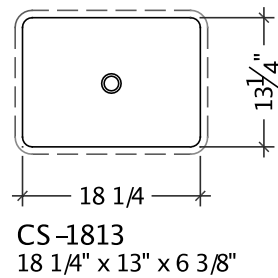
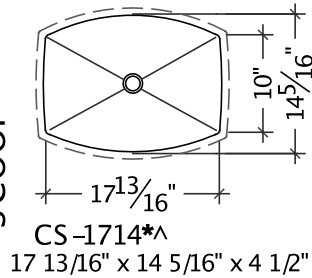

### RECTANGULAR "CRESCENT"

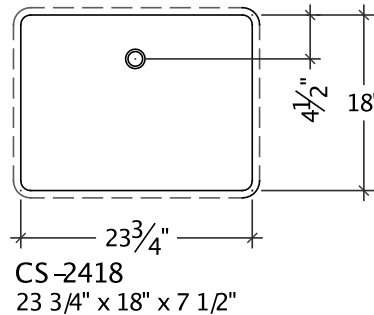
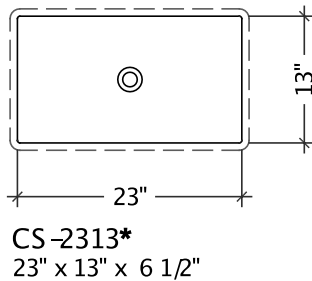
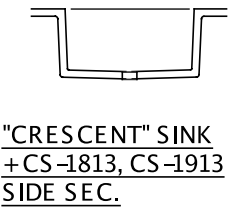
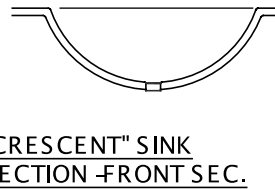
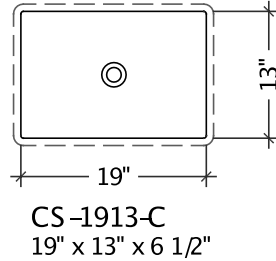
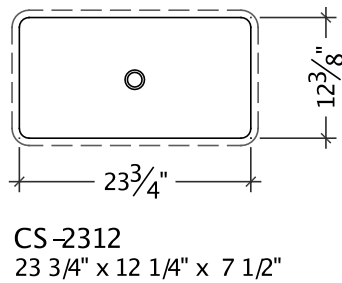

### RECTANGULAR "WEDGE"

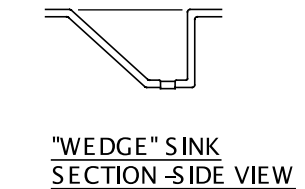
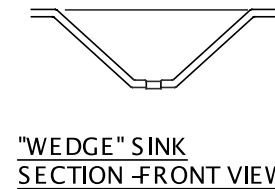
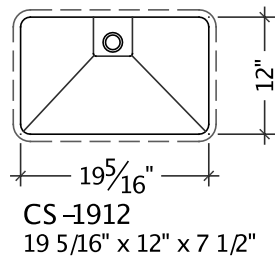

DIMENSIONS ARE INSIDE SINK

\* THESE MODELS ARE AVAILABLE AS MULTIPLE-SINK VANITIES  
<sup>^</sup> THESE MODELS CAN COMPLY WITH A.D.A. STANDARDS